



Status

<input type="checkbox"/> Bestellung	<input type="checkbox"/> Kostenvoranschlag
<input type="checkbox"/> Demoanforderung	<input type="checkbox"/> Auftragsbestätigung

Eingabedatum	
Auftragsnummer	

Daten des Händlers

Händler	
Adresse	
PLZ / Ort	
Kontaktperson	
E-mail	
Tel	
Fax	

Lieferadresse

Name	
Adresse	
PLZ / Ort	
Kontaktperson	
Kom.	

Daten des Benutzers

Vor- und Nachname	
Alter	
Gewicht	Max. 120 kg
Gesamtgröße stehend - cm	
1) Hüftbreite sitzend - cm	
2) Oberschenkelänge - cm	
3) Unterschenkelänge (U) - cm	
4) Ellenbogenhöhe (V) - cm	

Wichtig Bitte ausfüllen

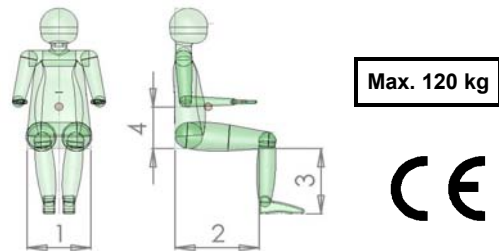

Gewünschte Einstellung

Sitzhöhe vorne (F) - cm		(53)
Sitzhöhe hinten (G) - cm		(49)
Radbilanz / Schwerpunkt (W) - cm		(7)

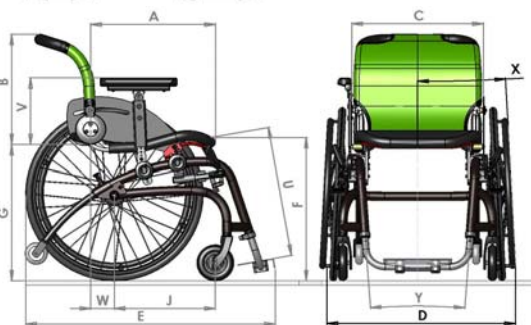

Bemerkungen Bestellblatt

Festverschweißt ==> separates Bestellblatt
--

Grundpreis	€	2.490
Alle Preise exkl. MwSt.		

Legende :

Hellgrau = Standard	Dunkelgrau = Festbetrag nicht rabattierfähig
---------------------	--

Bestellbeispiel

OlympicHopper Grundausstattung	+ Kleiderschutz fest, Aluminium	+ Kippschutz links	+ RCA 1.5 ==>	€ 2.990
--------------------------------	---------------------------------	--------------------	---------------	----------------

(Art : 270 - 000 x x) Adaptivrollstuhl, Aluminiumrahmen, mit integrierter Fußraste

Gesamtdaten des Rollstuhls

Sonderbau :



Alle Preise exkl. MwSt.	Auslagen Optionen	
	Auslagen Sonderbau	
	Gesamt Verkaufspreis	
	Verpackungs- und Transportkostenanteil	€ 45

Lieferung	
------------------	--





Seriennummer	
---------------------	--

Unsere Allgemeinen Geschäftsbedingungen sind im Internet einsehbar : www.O4.eu Technische Änderungen und Druckfehler vorbehalten
 O4 - GmbH Tel : +49 2821 711 4943 Siemensstraße 31, 47533 Kleve, Deutschland Fax : +49 2821 711 4946 E-mail : sales@O4.eu www.O4.eu

Sitzbreite (C)

<input type="checkbox"/> 34,0 cm	<input type="checkbox"/> 36,5 cm	<input type="checkbox"/> 39,0 cm	<input checked="" type="checkbox"/> 41,5 cm	<input type="checkbox"/> 44,0 cm	<input type="checkbox"/> 46,5 cm	<input type="checkbox"/> 49,0 cm	<input type="checkbox"/> 51,5 cm	
<input type="checkbox"/> 31,5 cm	<== längere Lieferzeit, auf Anfrage			==> Verstärkt bis 160 kg		<input type="checkbox"/> 54 cm	<input type="checkbox"/> 56,5 cm	<input type="checkbox"/> 59,0 cm
Kein Aufpreis						€ 100	€ 100	€ 100

Rahmenform (Y)

<input type="checkbox"/> 	<input type="checkbox"/> 	<input type="checkbox"/> 	<input type="checkbox"/> 
U-Form	V8	V16	Abduktion
Standard	Standard	Standard	€ 100
Fußraum = Sitzbreite - 10 cm	lieferbar ab Sitzbreite 39 cm Fußraum = Sitzbreite - 15 cm	lieferbar ab Sitzbreite 44 cm Fußraum = Sitzbreite - 20 cm	Fußraum = Sitzbreite - 5 cm
Siehe Rahmenlänge	Siehe Rahmenlänge	Siehe Rahmenlänge	Art : 270-700 x x

Rahmenlänge (J)

<input type="checkbox"/> 34 cm	<input type="checkbox"/> 40 cm	<input type="checkbox"/> 45 cm
empfohlene Sitztiefen 40 - 45 cm	empfohlene Sitztiefen 42,5 - 50 cm	empfohlene Sitztiefen 45 - 50 cm
Art : 270-100 x x	Art : 270-200 x x	Art : 270-600 x x

Radsturz (X)

<input type="checkbox"/> 0°	<input type="checkbox"/> 3°	<input type="checkbox"/> 6°	<input type="checkbox"/> 9°
-----------------------------	-----------------------------	-----------------------------	-----------------------------

Sitztiefe (A)

<input type="checkbox"/> 37,5 cm	<input type="checkbox"/> 40,0 cm	<input checked="" type="checkbox"/> 42,5 cm	<input type="checkbox"/> 45,0 cm	<input type="checkbox"/> 47,5 cm	<input type="checkbox"/> 50,0 cm
auf Anfrage	Standard	Standard	Standard	Standard	auf Anfrage

Sitz

<input type="checkbox"/> 	<input type="checkbox"/> 	<input type="checkbox"/> 
Sitz für Fremdkissen, Aluminium Auflage; nur in Kombination mit RCA 1.5	Sitz für Fremdkissen, Seat E-Lastica; nur in Kombination mit RCA 1.5	Sitz Kontur, gepolstert
Standard	€ 100	€ 180
Art : 100-130 x x	Art : 100-140 x x	Art : 100-100 x x



Sitzkissen

<input type="checkbox"/> 	<input type="checkbox"/> 	<input type="checkbox"/> Maßarbeit
Sitzkissen Weich	Sitzkissen Hart	in Anfertigung nach Skizze
3 cm Latex + 3 cm Verbundschaum	6 cm Verbundschaum	
€ 159	€ 85	auf Anfrage
Art : 100-411 x x	Art : 100-412 x x	-



Rückendrehgelenk

<input type="checkbox"/> 	<input type="checkbox"/> 	<input type="checkbox"/> Ab April 2010 lieferbar
RCA 1	RCA 1.5	RCA 1.5 - einfach
Rückendrehgelenk zentriert (hellgrau)	Rückendrehgelenk 2,5 cm rückversetzt (schwarz)	Rückendrehgelenk 2,5 cm rückversetzt - mechanisch einstellbar (schwarz)
€ 200	€ 320	Kein Aufpreis
Art : 100-32000	Art : 100-36000	Art : 100-37000

Rückenform

<input type="checkbox"/>		<input type="checkbox"/>	
	Standard		Rückenlehne Frauen
	Standard		€ 200
	Art : 100-200 x x		Art : 100-220 x x

Rückenhöhe (B)

<input type="checkbox"/>	<input type="checkbox"/>	<input type="checkbox"/>	<input type="checkbox"/>	. . cm
				
Höhe 40 cm	Höhe 45 cm	Höhe 50 cm		^Sonderhöhe^
Standard	Standard	Standard		€ 150

Farbe Rückenpolsterung





<input type="checkbox"/>	<input type="checkbox"/>	<input type="checkbox"/>	<input type="checkbox"/>	<input type="checkbox"/>	<input type="checkbox"/>	<input type="checkbox"/>	<input type="checkbox"/>	<input type="checkbox"/>	Wechselbezug
									Farbe :
Orange	Rot	Schwarz	Blau	Dunkelblau	Grau	Dunkelrot			€ 75
Standard	Standard	Standard	Standard	€ 30	€ 30	€ 30			
Art: 100-400 x x	Art: 100-401 x x	Art: 100-402 x x	Art: 100-403 x x	Art: 100-405 x x	Art: 100-406 x x	Art: 100-404 x x			

Radgrößen

Mögliche Sitzhöhe siehe Maßblatt !!

<input type="checkbox"/>	<input type="checkbox"/>	<input type="checkbox"/>	<input type="checkbox"/>	<input type="checkbox"/>
22" x 1 - (25 - 489)	24" x 1 - (25 - 540)	25"	26" x 1 - (25 - 590)	28"
Kein Aufpreis	Standard	Auf Anfrage	Kein Aufpreis	Auf Anfrage
nur in Kombination mit 4" Vorderrädern	Marathon Plus Evolution Reifen		Marathon Plus Evolution Reifen	

Antriebsräder





Satz		Satz		Satz		Antrieb Links		Antrieb Rechts
<input type="checkbox"/>		<input type="checkbox"/>		<input type="checkbox"/>		<input type="checkbox"/>		<input type="checkbox"/>
Standard		Trommelbremse		Edco Nabenbremse		Einhandantrieb - Sitzhöhe wird 2 cm höher (Vorne und Hinten) - nicht möglich mit 9" Radsturz		
Standard		Auf Anfrage		€ 190		Auf Anfrage		
Art : 991 - x x 201		Art : 991 - 42 x x x		Art : 991 - x x 101		Art : 991 - 41 x x x		

<h3>Alber-Antriebe</h3> <p>Antriebe werden verkauft und angebaut durch die Ulrich Alber GmbH. Der Rollstuhl wird von O4 mit Standard Rädern ausgerüstet.</p>		<h3>Leichtgewichträder</h3> <p>Preise und Liefertermin auf Anfrage</p>	
<input type="checkbox"/>		<input type="checkbox"/>	
	Rahmenanpassung für Alber E-motion - Lieferung Antrieb von Alber		Rahmenanpassung für Alber E-fix - Lieferung Antrieb von Alber
	€ 100		€ 100
	Art : 991 - 40 x 01		Art : 991 - 40 x 11
<input type="checkbox"/>		<input type="checkbox"/>	
	BOR		Sonder
	^ BOR ^ Satz Leichtgewichtrad		^ Sonder ^ Satz Leichtgewichtrad
	Auf Anfrage		Auf Anfrage
	Art : 991 - 43 x x x		Art : 991 - 43 x x x

Zubehör (Paar)

<input type="checkbox"/>	<input type="checkbox"/>	<input type="checkbox"/>	<input type="checkbox"/>	<input type="checkbox"/>
				
Speichenschutz transparent	Speichenschutz mit O4-Aufdruck	Greifreifen-überzug	TETRA-Greifreifen	PARA-Greifreifen
€ 120	Auf Anfrage	€ 89	Auf Anfrage	Auf Anfrage
Art : 991 - 60 x 01	Art : 991 - 60 x 02	Art : 991-61x01	-	-

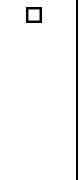



Bremsen

Satz <input type="checkbox"/>	Satz <input type="checkbox"/>	Links <input type="checkbox"/>	Rechts <input type="checkbox"/>	Satz <input type="checkbox"/>
				
Ziehbremse (ziehen zum Bremsen)	Druckbremse (drücken zum Bremsen)	Lange Druckbremse, abklappbar (drücken zum Bremsen)		S-Bremse
Standard	Standard	€ 25	€ 25	€ 50
Art : 992 - 07303	Art : 992 - 07304	Art : 992 - 07105	Art : 992 - 07205	Art : 992 - 07302



Lenkräder (Satz)

<input type="checkbox"/>	<input type="checkbox"/>	Mögliche Sitzhöhen siehe technisches Maßblatt !!	
			
Soft 5" Kunststoff	Soft 4" Kunststoff		
Standard	Standard		
Art : 991 - 05001	Art : 991 - 04001		
<input type="checkbox"/>	<input type="checkbox"/>	<input type="checkbox"/>	<input type="checkbox"/>
			
Hart 5" Aluminium	Hart 4" Aluminium	Hart 5" Kunststoff	Hart 4" Kunststoff
€ 115	€ 90	€ 15	€ 15
Art : 991 - 05003	Art : 991 - 04003	Art : 991 - 05002	Art : 991 - 04002





Fußraste (U)

<input type="checkbox"/>	<input type="checkbox"/>	<input type="checkbox"/>	<input type="checkbox"/>
			
gebogen	rechtwinklig	hochklappbar 1-teilig	hochklappbar 2-teilig
Unterschenklänge 41 bis 46 cm bei niedrigster Vorderer Sitzhöhe mit 24" Antriebsrad	Unterschenklänge 35 bis 40 cm bei niedrigster Vorderer Sitzhöhe mit 24" Antriebsrad	Einsteigfußraum : min 24 cm U-Form : Ab Sitzbreite 39 cm V8 : Ab Sitzbreite 44 cm	nur mit U-Form-Rahmen Sitzbreite 39 bis 46,5 cm Kunststoff-Fußplatten, andere Sitzbreiten Aluminium-Fußplatten
Standard	Standard	€ 199	€ 170
Art : 200 - 381 x x	Art : 200 - 382 x x	Art : 200 - 383 x x	Art : 200 - 384 x x





Fußplatten

<input type="checkbox"/>	<input type="checkbox"/>	<input type="checkbox"/>	<input type="checkbox"/>
			Maßarbeit
Standard (23 x 12 cm)	Breit (29 x 12 cm)	Tief (23 x 19 cm)	in Anfertigung nach Skizze
	U-Form: Ab Sitzbreitenmaß 39 cm V8 : Ab Sitzbreitenmaß 44 cm		
Standard	€ 25	€ 25	€ 75
Art : 200 - 38009	Art : 200 - 38010	Art : 200 - 38040	Art : 200 - 380 x x

Kippschutz

Links	Rechts	Links	Rechts	Links	Rechts	Links	Rechts
<input type="checkbox"/>		<input type="checkbox"/>		<input type="checkbox"/>		<input type="checkbox"/>	
Kippschutz - höhenverstellbar		Kippschutz - 360° drehbar (einseitig montierbar)		Ankippbügel - fest (nicht in Kombination mit Kippschutz-Paar)		Stockhalter - montiert an Ankippbügel	
€ 120	€ 120	€ 180	€ 180	€ 50	€ 50	€ 25	€ 25
Art : 290 - 30000		Art : 200-34000		Art : 200-20050		Art : 992-11002	

Seitenteil (& Armlehne)

Satz	Satz	Satz	Satz
<input type="checkbox"/>		<input type="checkbox"/>	
<input type="checkbox"/>		<input type="checkbox"/>	
Kleiderschutz fest, Aluminium		Kleiderschutz fest mit Spritzschutz, Aluminium (ab April 2010 lieferbar)	
Kleiderschutz fest mit Spritzschutz, Carbon		höhenverstellbare Armlehne, abnehmbar, winkeleinstellbar Nur in Kombination mit Kleiderschutz ohne Spritzschutz	
€ 60		€ 180	
€ 299		€ 175	
Art : 100 - 96040		Art : 100 - 96050	
Art : 100 - 96010		Art : 100 - 96170	

Zubehör

<input type="checkbox"/>		<input type="checkbox"/>		<input type="checkbox"/>		<input type="checkbox"/>	
höhenverstellbarer Schiebebügel		Kopfstütze		Inkontinenz-Schutzhülle		Sicherheitsgurt	
€ 225		auf Anfrage		€ 75		auf Anfrage	
Art : 100 - 210 x x		Art : 100 - 220 x x		Art : 100 - 112 x x		Art : 992 - 04002	
<input type="checkbox"/>		<input type="checkbox"/>		1 Stück		2 Stück	
Wadenband		Therapeutisch		Anpaßbarer Rückengurt mit Seat-E-Lastica Material , 5 cm breit , einstellbar		Anpaßbarer Rückengurt mit Seat-E-Lastica Material , 10 cm breit , einstellbar	
€ 25		auf Anfrage		€ 51	€ 102	€ 51	€ 102
Art : 992 - 04001		-		Art : 100 - 4605 x		Art : 100 - 4610 x	

Bitte senden Sie uns dieses Formular komplett ausgefüllt an unsere Fax Nr : +49 2821 711 4946

Unsere Allgemeinen Geschäftsbedingungen sind im Internet einsehbar : www.O4.eu
O4 - GmbH Tel : +49 2821 711 4943 Siemensstraße 31, 47533 Kleve, Deutschland

Technische Änderungen und Druckfehler vorbehalten
Fax : +49 2821 711 4946 E-mail : sales@O4.eu www.O4.eu

Technisches Maßblatt OlympicHopper

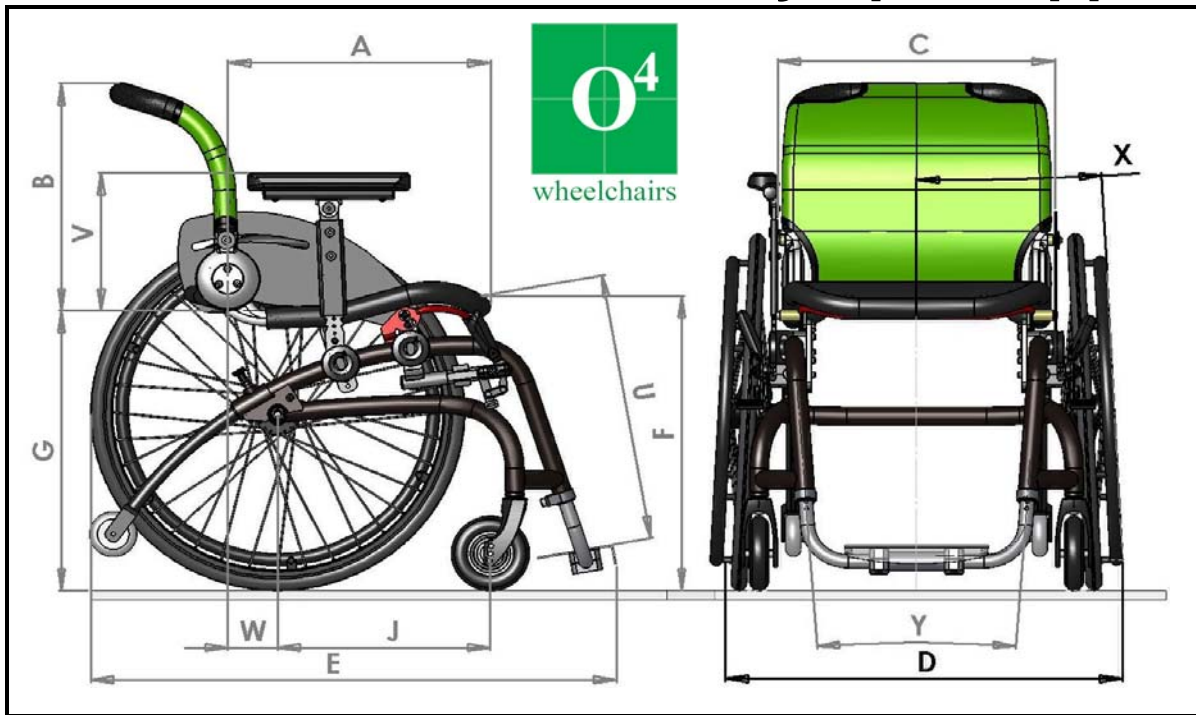

Beschreibung	Fig.	Maß	Normstuhl
Gesamtlänge (inklusive Fußstützen)	E	95 cm	95 cm
Gesamtbreite	D	Sitzbreite (=C) + 22 cm	66 cm
Gesamtgewicht	-	15 - 17 kg	16 kg
Gesamtlänge, ohne Räder und Rücken abgeklappt	T5	87 cm	87 cm
Gesamtbreite, ohne Räder und Rücken abgeklappt	-	Sitzbreite (=C) + 10,5 cm	55 cm
Gesamthöhe, ohne Räder und Rücken abgeklappt	T4	58 cm	58 cm
Rahmengewicht ohne Räder (Transportgewicht)	-	11 - 12 kg	11,5 kg
Sitztiefe	A	(37,5) - 40 - 42,5 - 45 - 47,5 - 50 cm	42,5 cm
Sitzbreite	C	(31,5)- 34 - 36,5 - 39 - 41,5 - 44 - 46,5 - 49 - 51,5 -(54/56,5/59)cm	44 cm
Sitzhöhe vorne; Oberkante Sitzrahmen-Vorderseite	F	45 - 62 [50 - 52] cm	53 cm
Sitzhöhe hinten	G	(42 möglich mit großem Keilsitz) 43 - 61 [47 - 49] cm	49 cm
Rückenwinkel-Verstellbereich	-	90° - 115° + 10° (Transport)	-
Rückenhöhe	B	40 - 45 - 50 - 65 cm	40 cm
Unterschenkellänge	U	35 - 50 cm	39 cm
Rahmenkröpfung	Y	Parallel - 8° - 16°	parallel
Radsturz	X	0° - 3° - 6° - 9°	3°
Radstand; jeweils Achsmittle	J	34 - 40 - (45) cm	34 cm
Minimaler Wendekreis	-	110 cm (bei 40 Rahmen)	110 cm
Maximales Benutzergewicht	-	Max. 120 kg	-

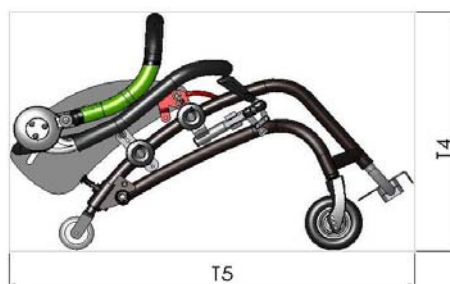

Mögliche Sitzhöhen

Vorderrad (inch)	Gabelhöhe (inch)	Hinterrad (inch)	Sitzhöhe Vorne (cm)		Sitzhöhe Hinten (cm)		Armlehnenhöhe (cm)	
			F		G		V	
			Min	Max	Min	Max	Min	Max
5	7	26	50	62	48	61	17	32
4	8	26	50	62	48	61	17	32
5	6	25	48	60	46	59	17	32
4	7	25	48	60	46	59	17	32
5	5	24	47	59	45	58	17	32
4	6	24	47	59	45	58	17	32
4	4	22	45	57	43	56	17	32

Beispiel Normstuhl :

Olympic_44-34-U-3_42,5-KPA-R1-40-RO_24-D_H5K-G5A

5	5	24	47 (2 cm Sitzadapter Vorne - niedrig gebaut)	45 (3 cm Sitzadapter Hinten)	22
---	---	----	---	--------------------------------	----